



IP Office 9.1

Avaya Radvision Installation Notes

Notice

While reasonable efforts have been made to ensure that the information in this document is complete and accurate at the time of printing, Avaya assumes no liability for any errors. Avaya reserves the right to make changes and corrections to the information in this document without the obligation to notify any person or organization of such changes.

Documentation disclaimer

"Documentation" means information published by Avaya in varying mediums which may include product information, operating instructions and performance specifications that Avaya may generally make available to users of its products and Hosted Services. Documentation does not include marketing materials. Avaya shall not be responsible for any modifications, additions, or deletions to the original published version of documentation unless such modifications, additions, or deletions were performed by Avaya. End User agrees to indemnify and hold harmless Avaya, Avaya's agents, servants and employees against all claims, lawsuits, demands and judgments arising out of, or in connection with, subsequent modifications, additions or deletions to this documentation, to the extent made by End User.

Link disclaimer

Avaya is not responsible for the contents or reliability of any linked websites referenced within this site or documentation provided by Avaya. Avaya is not responsible for the accuracy of any information, statement or content provided on these sites and does not necessarily endorse the products, services, or information described or offered within them. Avaya does not guarantee that these links will work all the time and has no control over the availability of the linked pages.

Warranty

Avaya provides a limited warranty on Avaya hardware and software. Refer to your sales agreement to establish the terms of the limited warranty. In addition, Avaya's standard warranty language, as well as information regarding support for this product while under warranty is available to Avaya customers and other parties through the Avaya Support website: <http://www.avaya.com/support> or such successor site as designated by Avaya. Please note that if you acquired the product(s) from an authorized Avaya Channel Partner outside of the United States and Canada, the warranty is provided to you by said Avaya Channel Partner and not by Avaya.

Licenses

THE SOFTWARE LICENSE TERMS AVAILABLE ON THE AVAYA WEBSITE, <HTTP://SUPPORT.AVAYA.COM/LICENSEINFO>, OR SUCH SUCCESSOR SITE AS DESIGNATED BY AVAYA, ARE APPLICABLE TO ANYONE WHO DOWNLOADS, USES AND/OR INSTALLS AVAYA SOFTWARE, PURCHASED FROM AVAYA INC., ANY AVAYA AFFILIATE, OR AN AVAYA CHANNEL PARTNER (AS APPLICABLE) UNDER A COMMERCIAL AGREEMENT WITH AVAYA OR AN AVAYA CHANNEL PARTNER. UNLESS OTHERWISE AGREED TO BY AVAYA IN WRITING, AVAYA DOES NOT EXTEND THIS LICENSE IF THE SOFTWARE WAS OBTAINED FROM ANYONE OTHER THAN AVAYA, AN AVAYA AFFILIATE OR AN AVAYA CHANNEL PARTNER; AVAYA RESERVES THE RIGHT TO TAKE LEGAL ACTION AGAINST YOU AND ANYONE ELSE USING OR SELLING THE SOFTWARE WITHOUT A LICENSE. BY INSTALLING, DOWNLOADING OR USING THE SOFTWARE, OR AUTHORIZING OTHERS TO DO SO, YOU, ON BEHALF OF YOURSELF AND THE ENTITY FOR WHOM YOU ARE INSTALLING, DOWNLOADING OR USING THE SOFTWARE (HEREINAFTER REFERRED TO INTERCHANGEABLY AS "YOU" AND "END USER"), AGREE TO THESE TERMS AND CONDITIONS AND CREATE A BINDING CONTRACT BETWEEN YOU AND AVAYA INC. OR THE APPLICABLE AVAYA AFFILIATE ("AVAYA").

Avaya grants you a license within the scope of the license types described below, with the exception of Heritage Nortel Software, for which the scope of the license is detailed below. Where the order documentation does not expressly identify a license type, the applicable license will be a Designated System License. The applicable number of licenses and units of capacity for which the license is granted will be one (1), unless a different number of licenses or units of capacity is specified in the documentation or other materials available to you. "Software" means Avaya's computer programs in object code, provided by Avaya or an Avaya Channel Partner, whether as stand-alone products, pre-installed, or remotely accessed on hardware products, and any upgrades, updates, bug fixes, or modified versions thereto. "Designated Processor" means a single stand-alone computing device. "Server" means a Designated Processor that hosts a software application to be accessed by multiple users. "Instance" means a single copy of the Software executing at a particular time: (i) on one physical machine; or (ii) on one deployed software virtual machine ("VM") or similar deployment.

Designated System(s) License (DS). End User may install and use each copy or an Instance of the Software only on a number of Designated Processors up to the number indicated in the order. Avaya may require the Designated Processor(s) to be identified in the order by type, serial number, feature key, Instance, location or other specific designation, or to be provided by End User to Avaya through electronic means established by Avaya specifically for this purpose.

Concurrent User License (CU). End User may install and use the Software on multiple Designated Processors or one or more Servers, so long as only the licensed number of Units are accessing and using the Software at any given time. A "Unit" means the unit on which Avaya, at its sole discretion, bases the pricing of its licenses and can be, without limitation, an agent, port or user, an e-mail or voice mail account in the name of a person or corporate function (e.g., webmaster or helpdesk), or a directory entry in the administrative database utilized by the Software that permits one user to interface with the Software. Units may be linked to a specific, identified Server or an Instance of the Software.

Database License (DL). End User may install and use each copy or an Instance of the Software on one Server or on multiple Servers provided that each of the Servers on which the Software is installed communicates with no more than an Instance of the same database.

CPU License (CP). End User may install and use each copy or Instance of the Software on a number of Servers up to the number indicated in the order provided that the performance capacity of the Server(s) does not exceed the performance capacity specified for the Software. End User may not re-install or operate the Software on Server(s) with a larger performance capacity without Avaya's prior consent and payment of an upgrade fee.

Named User License (NU). You may: (i) install and use the Software on a single Designated Processor or Server per authorized Named User (defined below); or (ii) install and use the Software on a Server so long as only authorized Named Users access and use the Software. "Named User," means a user or device that has been expressly authorized by Avaya to access and use the Software. At Avaya's sole discretion, a "Named User" may be, without limitation, designated by name, corporate function (e.g., webmaster or helpdesk), an e-mail or voice mail account in the name of a person or corporate function, or a directory entry in the administrative database utilized by the Software that permits one user to interface with the Software.

Shrinkwrap License (SR). You may install and use the Software in accordance with the terms and conditions of the applicable license agreements, such as "shrinkwrap" or "clickthrough" license accompanying or applicable to the Software ("Shrinkwrap License").

Heritage Nortel Software

"Heritage Nortel Software" means the software that was acquired by Avaya as part of its purchase of the Nortel Enterprise Solutions Business in December 2009. The Heritage Nortel Software currently available for license from Avaya is the software contained within the list of Heritage Nortel Products located at <http://support.avaya.com/LicenseInfo/> under the link "Heritage Nortel Products," or such successor site as designated by Avaya. For Heritage Nortel Software, Avaya grants Customer a license to use Heritage Nortel Software provided hereunder solely to the extent of the authorized activation or authorized usage level, solely for the purpose specified in the Documentation, and solely as embedded in, for execution on, or (in the event the applicable Documentation permits installation on non-Avaya equipment) for communication with Avaya equipment. Charges for Heritage Nortel Software may be based on extent of activation or use authorized as specified in an order or invoice.

Copyright

Except where expressly stated otherwise, no use should be made of materials on this site, the Documentation, Software, Hosted Service, or hardware provided by Avaya. All content on this site, the documentation, Hosted Service, and the Product provided by Avaya including the selection, arrangement and design of the content is owned either by Avaya or its licensors and is protected by copyright and other intellectual property laws including the sui generis rights relating to the protection of databases. You may not modify, copy, reproduce, republish, upload, post, transmit or distribute in any way any content, in whole or in part, including any code and software unless expressly authorized by Avaya. Unauthorized reproduction, transmission, dissemination, storage, and or use without the express written consent of Avaya can be a criminal, as well as a civil offense under the applicable law.

Virtualization

Each product has its own ordering code and license types. Note that each Instance of a product must be separately licensed and ordered. For example, if the end user customer or Avaya Channel Partner would like to install two Instances of the same type of products, then two products of that type must be ordered.

Third Party Components

"Third Party Components" mean certain software programs or portions thereof included in the Software or Hosted Service may contain software (including open source software) distributed under third party agreements ("Third Party Components"), which contain terms regarding the rights to use certain portions of the Software ("Third Party Terms"). As required, information regarding distributed Linux OS source code (for those Products that have distributed Linux OS source code) and identifying the copyright holders of the Third Party Components and the Third Party Terms that apply is available in the Documentation or on Avaya's website at: <http://support.avaya.com/Copyright> or such successor site as designated by Avaya. You agree to the Third Party Terms for any such Third Party Components.

Preventing Toll Fraud

"Toll Fraud" is the unauthorized use of your telecommunications system by an unauthorized party (for example, a person who is not a corporate employee, agent, subcontractor, or is not working on your company's behalf). Be aware that there can be a risk of Toll Fraud associated with your system and that, if Toll Fraud occurs, it can result in substantial additional charges for your telecommunications services.

Avaya Toll Fraud intervention

If you suspect that you are being victimized by Toll Fraud and you need technical assistance or support, call Technical Service Center Toll Fraud Intervention Hotline at +1-800-643-2353 for the United States and Canada. For additional support telephone numbers, see the Avaya Support website: <http://support.avaya.com>, or such successor site as designated by Avaya. Suspected security vulnerabilities with Avaya products should be reported to Avaya by sending mail to: securityalerts@avaya.com.

Trademarks

The trademarks, logos and service marks ("Marks") displayed in this site, the Documentation, Hosted Service(s), and Product(s) provided by Avaya are the registered or unregistered Marks of Avaya, its affiliates, or other third parties. Users are not permitted to use such Marks without prior written consent from Avaya or such third party which may own the Mark. Nothing contained in this site, the Documentation, Hosted Service(s) and Product(s) should be construed as granting, by implication, estoppel, or otherwise, any license or right in and to the Marks without the express written permission of Avaya or the applicable third party.

Avaya is a registered trademark of Avaya Inc.

All non-Avaya trademarks are the property of their respective owners.

Linux® is the registered trademark of Linus Torvalds in the U.S. and other countries.

Downloading Documentation

For the most current versions of Documentation, see the Avaya Support website: <http://support.avaya.com>, or such successor site as designated by Avaya.

Contact Avaya Support

See the Avaya Support website: <http://support.avaya.com> for Product or Hosted Service notices and articles, or to report a problem with your Avaya Product or Hosted Service. For a list of support telephone numbers and contact addresses, go to the Avaya Support website: <http://support.avaya.com> (or such successor site as designated by Avaya), scroll to the bottom of the page, and select Contact Avaya Support.

Contents

1. Overview

1.1 Avaya Radvision Components Overview.....	10
1.2 IP Office Components Overview.....	12
1.3 Small Enterprise Deployment.....	13
1.4 Large Enterprise Deployment.....	14
1.5 Known Interoperation Limitations.....	15

2. Small Enterprise Deployment

2.1 IP Office Deployment Process.....	19
2.2 Prerequisites.....	19
2.3 Checking the IP Office Licenses.....	20
2.4 Checking IP Office SIP Support.....	21
2.5 Creating IP Office Users.....	22
2.6 Creating IP Office SIP Extensions.....	23
2.7 Configuring the Scopia XT Series SIP Connection.....	25

3. Large Enterprise Deployment

3.1 IP Office Deployment Process.....	29
3.2 Prerequisites.....	29
3.3 Checking the IP Office Licenses.....	30
3.4 Checking IP Office SIP Support.....	31
3.5 System Default Codecs.....	32
3.6 Adding the SIP Trunk.....	33
3.7 Configuring the Scopia MCU.....	35
3.8 Adding a Short Code.....	36
3.8.1 Simple Short Code Example.....	36
3.8.2 Flexible Short Code Example.....	37
3.9 Creating IP Office Users.....	38
3.10 Creating IP Office SIP Extensions.....	39
3.11 Configuring the Scopia XT Series SIP Connection.....	41

4. Document History

Index	45
-------------	----

Chapter 1.

Overview

1. Overview

This document provides notes for the interoperability of Avaya Radvision video conferencing with Avaya IP Office systems.

- Avaya Radvision products are supported with IP Office Essential Edition, IP Office Preferred Edition, IP Office Advanced Edition or Server Edition systems running IP Office Release 8.1 Q3 2012 Service Pack (8.1.52), IP Office Release 8.0 FP1 and higher only.
- IP Office to Avaya Radvision interoperability is supported with Avaya Radvision components running Avaya Radvision Release 7.7 software and higher.

This document covers the following scenarios:

- [Small Enterprise Deployment](#)^[13]
This scenario uses a Scopia XT5000 as the video conferencing server (MCU) for up to 9 video conference users at any time in a single conference. Those users can be H.323 and SIP video devices and applications hosted by a Scopia XT Desktop Server.
- [Large Enterprise Deployment](#)^[14]
This scenario uses a Avaya Radvision Elite MCU (Scopia XT4200 or Scopia XT5000) as the video conferencing server.

	Small Enterprise Deployment	Large Enterprise Deployment
Conference Server (MCU)	Scopia XT5000	Elite Series MCU
Conference Capacity	1 conference only of up to 9 parties	Unlimited - according to the MCU capacity.
Conference Scheduling	No	Yes
Desktop and mobile access	Yes - via Scopia XT Desktop Server	Yes - via Scopia Desktop Server
External access (Firewall traversal)	Yes - via Scopia XT5000	Yes - via Scopia PathFinder Server
Point-to-point calls	Yes	Yes

Installer/Maintainer Knowledge

- This document assumes that you are familiar with using the applications in the IP Office Admin Suite (IP Office Manager, System Status Application, IP Office System Monitor) to configure and monitor an IP Office system.
- This document does not cover the configuration of the Avaya Radvision systems in detail. The separate Avaya Radvision documentation for the Avaya Radvision components used in the deployment cover that configuration. Avaya assume that you are either familiar with the installation and configuration of those components or supported by an experienced Avaya Radvision installer/maintainer.

1.1 Avaya Radvision Components Overview

This page gives a quick overview of the different Avaya Radvision system components supported by IP Office Release 8.1 Q3 2012 Service Pack (8.1.52). For full details of each component, refer to the relevant Avaya Radvision manual.

- IP Office to Avaya Radvision interoperability is supported with Avaya Radvision components running Avaya Radvision Release 7.7 software and higher.

Conference Servers

The central part of the video conference system is an Multipoint Conferencing Units (MCU). The MCU hosts the video conference. The MCUs supported for use with IP Office are:

- **Elite Series Conference Servers**

These MCUs support H.323 and SIP video devices, either directly or, for external devices, via a Scopia PathFinder Server. They also support users accessing video conferences using applications on their PC or mobile who connect via a Scopia Desktop Server. The different models of MCU support different video conferencing capacities and can be expanded in capacity by the addition of licenses to their configuration. Elite MCU series supported with IP Office are:

- **Elite 5000 MCU Series**

Supported with Avaya Radvision Release 7.7 and higher and IP Office Release 8.1 Q3 2012 Service Pack (8.1.52) and IP Office Release 8.1 Feature Pack 1.

- **Elite 6000 MCU Series**

Supported with Avaya Radvision Release 8.0 and IP Office Release 8.1 Q3 2012 Service Pack (8.1.52).

- **Scopia XT5000**

For small enterprise deployments, one Scopia XT5000 unit (see Conference Room Video Systems below) is put into MCU mode through the addition of licenses. There are two licensed MCU modes:

- **Scopia XT Series MCU Edition**

In this mode, the Scopia XT5000 acts as a video conferencing MCU hosting video conferences for H.323 and SIP video end points. You can choose a license for up to 4 or 9 participants.

- **Scopia XT Series SMB Edition**

In this mode, the Scopia XT5000 acts as a video conferencing MCU hosting video conferences for H.323 and SIP video end points and for Scopia XT Desktop Server clients. The license includes the software for a Scopia XT Desktop Server. You can choose a license for up to 4 or 9 participants.

Conference Room Video Systems

IP Office supports the following conference room systems. Each consists of a main unit, high-quality remote controllable video camera and room microphone/speaker. Each also provides ports for connection of additional microphones, multiple monitor displays and PC connections for media sharing.

- **Scopia XT4200**

The Scopia XT4200 offers dual 720p/60fps live video and content, HD audio, H.264 High Profile, Scalable Video Coding (SVC) and optional iPad control.

- **Scopia XT5000**

The Scopia XT5000 offers dual 1080p/60fps live video and content, HD audio, H.264 High Profile, Scalable Video Coding (SVC) and iPad control. For small enterprise deployments, a Scopia XT5000 is required to act as the conference server (see Conference Servers above).

Video Applications

- **Scopia XT Desktop Server/Scopia Desktop Server**

Scopia Desktop Server is a server application that lets users use the freely distributable Scopia PC Desktop or Scopia Mobile applications to participate in conferences. While internal users can use these applications, the Scopia Desktop Server supports NAT and firewall traversal, making it ideal for external parties to join a conference when required. The small enterprise deployment uses the Scopia XT Desktop Server; the large enterprise deployment uses the Scopia Desktop Server.

- **Scopia PC Desktop**

Scopia PC Desktop is a web browser plug-in that allows PC users to participate in conferences through their PC. The plug-in connects to the MCU via the Scopia XT Desktop Server or Scopia Desktop Server.

- **Scopia Mobile**

Scopia Mobile is an app that allows users to participate in conferences using their mobile devices. The plug-in connects to the MCU via the Scopia XT Desktop Server or Scopia Desktop Server.

- Scopia Mobile iOS allows iPad, iPhone and iPod Touch users to participate in conferences. Supported on iOS 4 and above.
 - Scopia Mobile Android allows Android device users to participate in conferences. Supported on Android 2.3 and above.

Personal Video Systems

IP Office supports the following high quality video system in a large enterprise deployment:

- **Scopia VC240**

The Scopia VC240 is a high-resolution desktop monitor with integrated HD videoconferencing camera and microphone. The Scopia VC240 can operate as a standalone desktop HD videoconferencing device or as a 24-inch high-resolution monitor and camera in conjunction with a PC. The Scopia VC240 registers with the Avaya Radvision system as a SIP or H.323 device. It does not register to the IP Office system as an IP Office extension.

Additional Components

For the large enterprise deployment scenario, the following additional components are used:

- **iView Management**

This application provides a single interface through which all other Avaya Radvision components can be monitored, administered and configured. It can remotely configure the other components including performing software and firmware upgrades. It also provides conference monitoring and scheduling facilities.

- **Scopia PathFinder Server**

The Scopia PathFinder Server provides firewall and NAT traversal for external H.323 devices. This allows external H.323 video devices to join video conferences hosted in the customer's private network whilst retaining network security. The Scopia PathFinder Server works in conjunction with a Scopia Elite Series MCU.

1.2 IP Office Components Overview

Supported IP Office Releases

The following IP Office releases support IP Office to Avaya Radvision interoperation:

- **Small Enterprise Deployment:** 8.1 Q3 2012 Service Pack (8.1.52) or IP Office Release 8.1 Feature Pack 1.
- **Large Enterprise Deployment:** 8.1 Q3 2012 Service Pack (8.1.52).

Supported IP Office Platforms

The following IP Office platforms and operating modes support Avaya Radvision:

- **IP Office IP500 V2**
Operating in *Essential Edition*, *Preferred Edition* or *Advanced Edition* mode.
- **IP Office Server Edition**

Supported IP Office Telephones

The following IP Office extension telephones supported for Avaya Radvision:

- **Avaya 96x1 Series H.323 telephones**
- **Avaya 9500 Series digital telephones**
- **Avaya 1600 Series H.323 telephones**
- **Avaya 1408 and 1416 digital telephones**
- **Avaya B179 SIP conference telephone**
- **Avaya Communicator** (*audio features only*)
Not supported in large enterprise deployments.

1.3 Small Enterprise Deployment

For customers with simple small-scale video conferencing needs, the small enterprise deployment uses a Scopia XT5000 unit licensed to act as the conferencing server. It can do this for 4 or 9 conference parties in a single video conference.

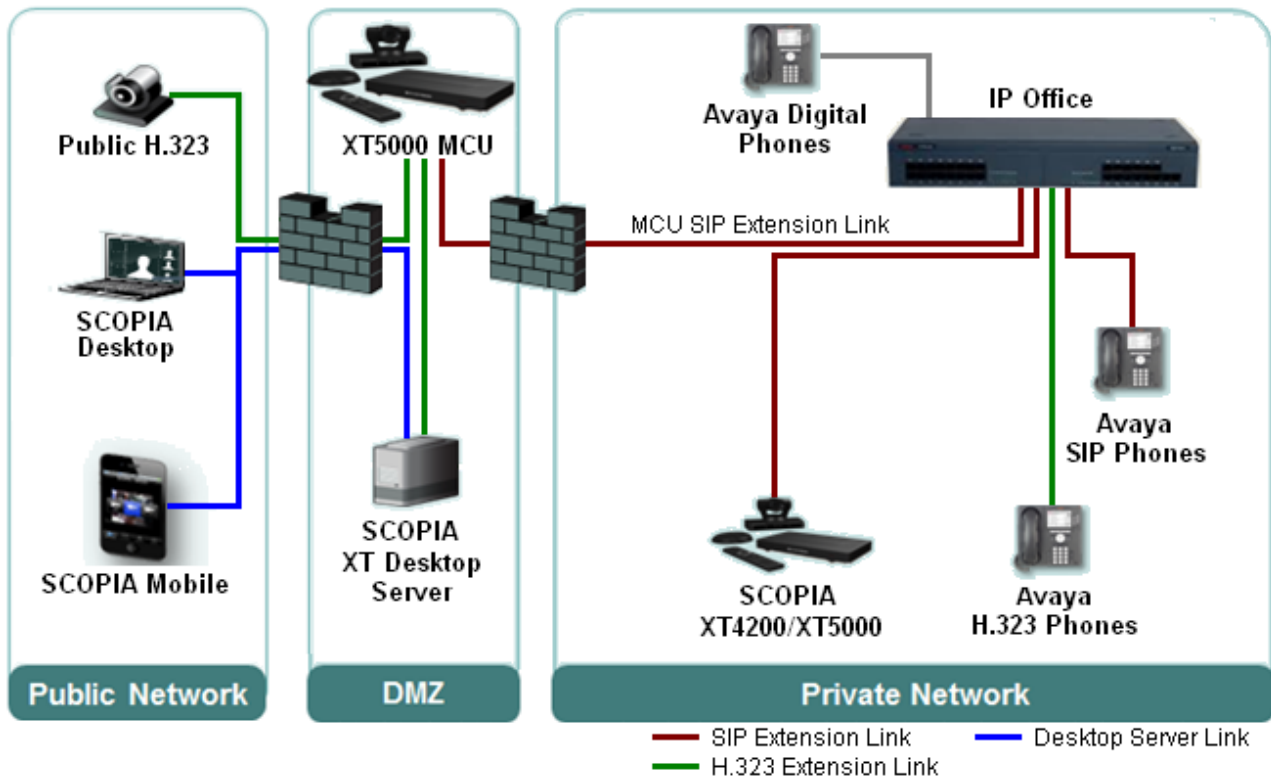

- One Scopia XT5000 is licensed and configured for MCU operation using a **SCOPIA XT Series MCU Edition** or **SCOPIA XT Series SMB Edition** license. The license used enables either 4 or 9 parties in a video conference.
 - Placing the MCU mode Scopia XT5000 in the customer DMZ allows external H.323 video devices to access conferences without having to configure NAT and other firewall traversal for external devices into the customer's internal private network.
 - The MCU mode Scopia XT5000 is licensed and registered as a SIP extension on the IP Office system. Other IP Office users, incoming call routes and short code access the video conference by using the extension number assigned to the user created for the MCU mode Scopia XT5000.
- Any other Scopia XT Series systems on the customer's network registers with the IP Office as a SIP extension.
- The Scopia XT Desktop Server allows users using the Scopia PC Desktop on PCs and the Scopia Mobile application on mobile devices to join conferences. Placed in the customer's DMZ, the Scopia Desktop Server performs NAT and firewall functions for users if external to the customer's private network. This requires the **SCOPIA XT Series SMB Edition** license.

Supported IP Office Telephones

The following IP Office extension telephones supported for Avaya Radvision:

- **Avaya 96x1 Series H.323 telephones**
- **Avaya 9500 Series digital telephones**
- **Avaya 1600 Series H.323 telephones**
- **Avaya 1408 and 1416 digital telephones**
- **Avaya B179 SIP conference telephone**
- **Avaya Communicator** (*audio features only*)

1.4 Large Enterprise Deployment

For customers with requirements for large scale and multiple conferences, an Elite series MCU is required (or in fact multiple Elite series MCUs). Each Elite Series MCU supports multiple conference parties in multiple conferences.

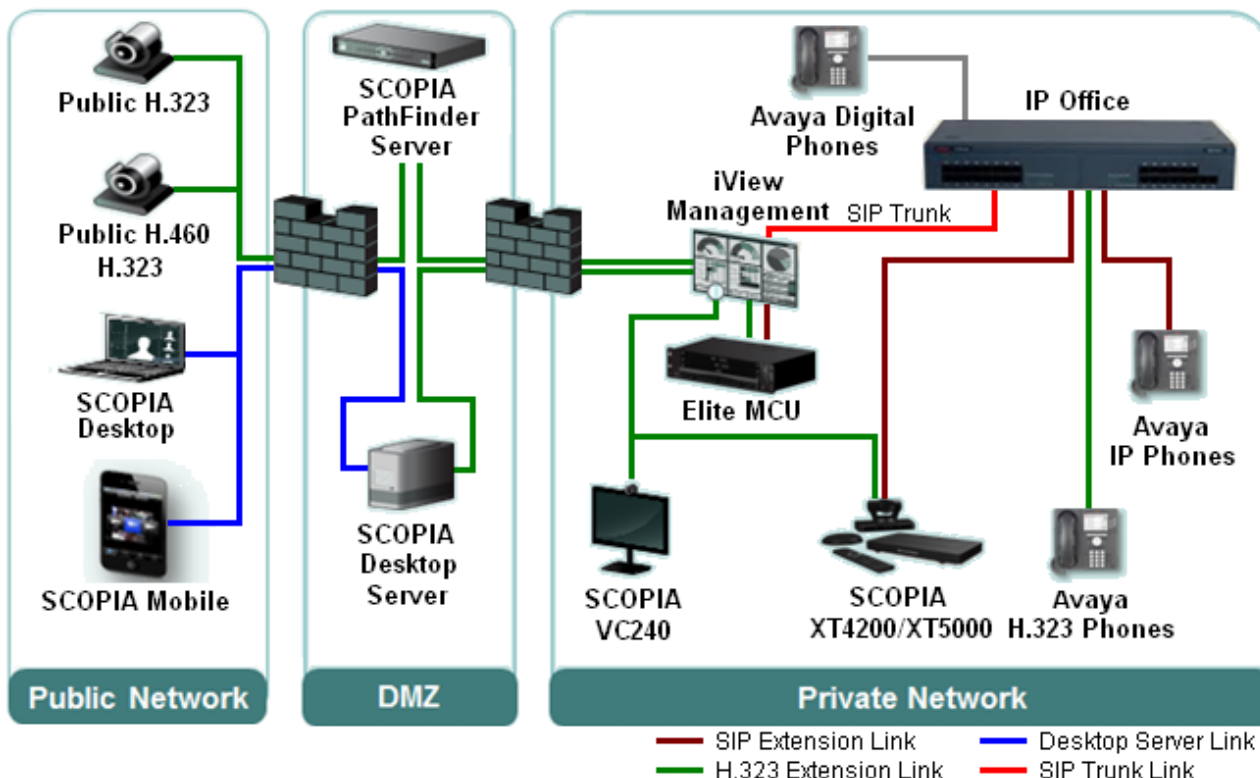

- The customer's private network includes the Elite MCU or MCUs.
- Installed on a customer server, iView Management provides centralized management of all the Avaya Radvision components and conferences including conference scheduling.
 - A SIP trunk links the IP Office system to the iView Management server.
 - The Avaya Radvision video devices on the customer's network connect to the iView Management server.
- The Scopia Desktop Server allows users using the Scopia PC Desktop on PCs and the Scopia Mobile application on mobile devices to join conferences. Placed in the customer's DMZ, the Scopia Desktop Server performs NAT and firewall functions for users external to the customer's private network.
- The Scopia PathFinder Server in the customer's DMZ provides NAT and firewall traversal for external H.323 video devices to join conferences whilst maintaining security of the customer network.
- In this deployment, Scopia VC240 video systems register with the Avaya Radvision system as their gatekeeper. Scopia XT4200 and Scopia XT5000 video systems register with both the IP Office and the Avaya Radvision system.

Supported IP Office Telephones

The following IP Office extension telephones supported for Avaya Radvision:

- **Avaya 96x1 Series H.323 telephones**
- **Avaya 9500 Series digital telephones**
- **Avaya 1600 Series H.323 telephones**
- **Avaya 1408 and 1416 digital telephones**
- **Avaya B179 SIP conference telephone**

1.5 Known Interoperation Limitations

The following are the current known limitations for Avaya Radvision interoperation.

- Connections between IP Office end points and Avaya Radvision components must use **Direct Media**.
- IP Office does not support:
 - Short code feature dialing for Avaya Radvision video devices. That includes paging, call queue and call pickup short code features. The only exceptions are dial short code features.
 - Account codes and authorization codes for Avaya Radvision video devices.
 - Mid-call features, such as hold and transfer, from Avaya Radvision video devices.
 - Avaya Radvision video devices as IP Office hunt group members.
- The Scopia XT Series units do not support:
 - When registered to the IP Office, the Content Sharing and Far End Camera Control features are not supported on SIP calls. They are supported on H.323 calls.
 - The G.729 audio codec is not supported with Scopia XT Series end points. Remove the codec from the IP Office configuration of those extensions.
- The IP Office Video Softphone is currently not supported as a video endpoint in Avaya Radvision video conferences.
- The use of Avaya Communicator with an Elite Series MCU and therefore in a large enterprise deployment is not support.

For IP Office Release 9.0, the following previous restrictions have now been removed:

- **BFCP Support**
XT5000 DVI video port can be used to send a video stream for content sharing controlled by remote (called Binary Floor Control Protocol (BFCP)). In presentation mode, the DVI video stream has priority. That is, if the device can show both it shows both, if it can only show one it shows the content sharing stream.
- **SIP Trunks**
Incoming video calls on SIP trunks are supported so long as the trunk uses Direct Media.

Chapter 2.

Small Enterprise Deployment

2. Small Enterprise Deployment

For customers with simple small-scale video conferencing needs, the small enterprise deployment uses a Scopia XT5000 unit licensed to act as the conferencing server. It can do this for 4 or 9 conference parties in a single video conference.

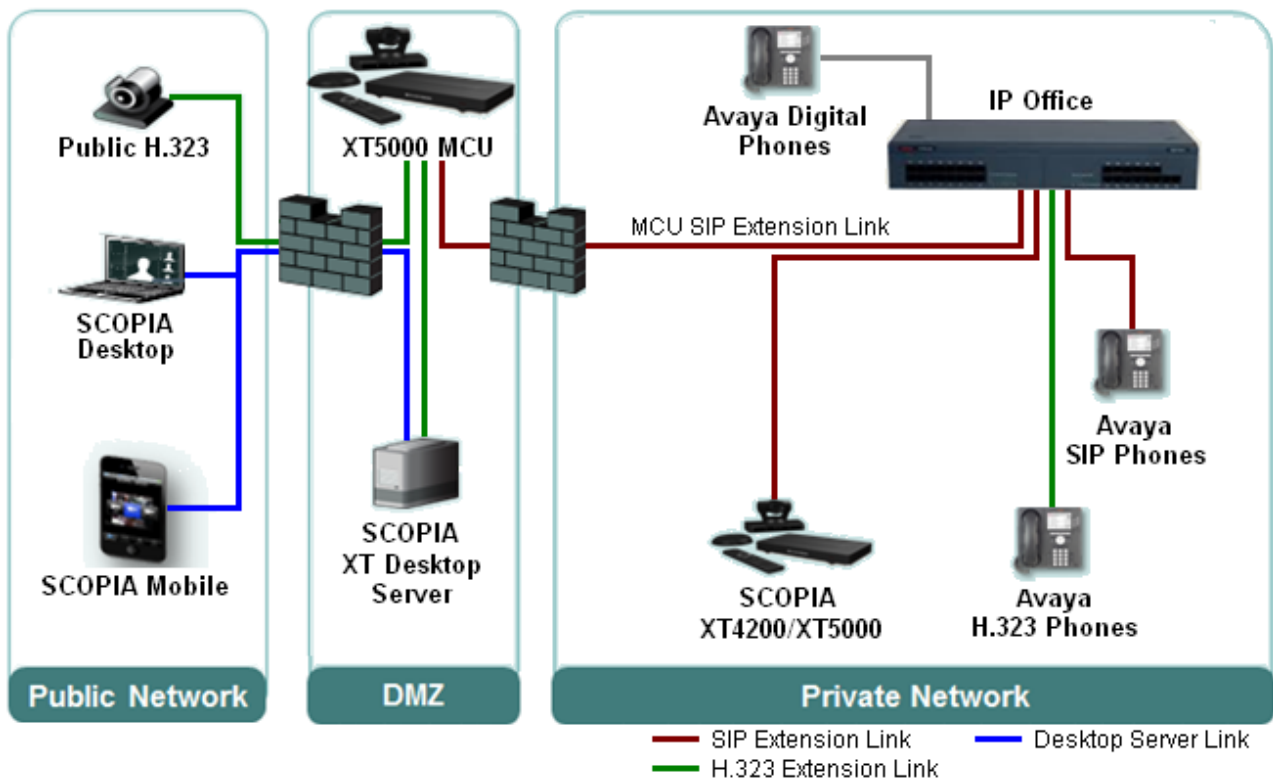

- One Scopia XT5000 is licensed and configured for MCU operation using a **SCOPIA XT Series MCU Edition** or **SCOPIA XT Series SMB Edition** license. The license used enables either 4 or 9 parties in a video conference.
 - Placing the MCU mode Scopia XT5000 in the customer DMZ allows external H.323 video devices to access conferences without having to configure NAT and other firewall traversal for external devices into the customer's internal private network.
 - The MCU mode Scopia XT5000 is licensed and registered as a SIP extension on the IP Office system. Other IP Office users, incoming call routes and short code access the video conference by using the extension number assigned to the user created for the MCU mode Scopia XT5000.
- Any other Scopia XT Series systems on the customer's network registers with the IP Office as a SIP extension.
- The Scopia XT Desktop Server allows users using the Scopia PC Desktop on PCs and the Scopia Mobile application on mobile devices to join conferences. Placed in the customer's DMZ, the Scopia Desktop Server performs NAT and firewall functions for users if external to the customer's private network. This requires the **SCOPIA XT Series SMB Edition** license.

Supported IP Office Telephones

The following IP Office extension telephones supported for Avaya Radvision:

- **Avaya 96x1 Series H.323 telephones**
- **Avaya 9500 Series digital telephones**
- **Avaya 1600 Series H.323 telephones**
- **Avaya 1408 and 1416 digital telephones**
- **Avaya B179 SIP conference telephone**
- **Avaya Communicator** (audio features only)

2.1 IP Office Deployment Process

The following stages are gone through in the process of integrating the Avaya Radvision system. To allow calls between the IP Office and the MCU, the MCU registers as a SIP extension on the IP Office system. Calls to the conference then use its IP Office extension number.

For this example, we assume that the Scopia XT5000 MCU added to the IP Office configuration has the extension number 800. In addition, any other Scopia XT Series devices register with the IP Office system as a SIP extension.

1. [Check the prerequisites](#) ^[19].
2. [Check or add the IP Office licenses](#) ^[20].
3. [Check IP Office SIP extension support](#) ^[21].
4. [Create an IP Office user](#) ^[22].
5. [Create an IP Office SIP extension](#) ^[23].
6. [Configure the Scopia XT Series SIP settings](#) ^[25].

2.2 Prerequisites

General Prerequisites

- This document assumes that you are familiar with using the applications in the IP Office Admin Suite (IP Office Manager, System Status Application, IP Office System Monitor) to configure and monitor an IP Office system.
- This document does not cover the configuration of the Avaya Radvision systems in detail. The separate Avaya Radvision documentation for the Avaya Radvision components used in the deployment cover that configuration. Avaya assume that you are either familiar with the installation and configuration of those components or supported by an experienced Avaya Radvision installer/maintainer.

IP Office Prerequisites

Avaya Radvision devices are supported on IP Office systems meeting the following prerequisites:

- **IP Office Platform:**
IP Office IP500 V2 or <MIDSIZE%>.
- **IP Office Software Release:**
The IP Office system should be running IP Office Release 8.1 Q3 2012 Service Pack (8.1.52) or IP Office Release 8.1 Feature Pack 1 or higher core software.
- **IP Office Operating Mode:**
The IP Office system must be configured to run in either IP Office Essential Edition, IP Office Preferred Edition, IP Office Advanced Edition or Server Edition mode.
- **VCM Resources:**
Calls to and from IP devices (extension and trunks) require the IP Office system to support VCM channels. For IP Office IP500 V2 system those are provided by the installation of IP500 VCM cards or IP500 Combinations cards. Refer to the IP Office Installation Manual for full details.
- **IP Office Licenses:**
The following IP Office licenses are used specifically for the deployment:
 - Each Scopia XT4200 and Scopia XT5000 device in the deployment is registered with the IP Office system as a SIP extension. To do this, each uses one instance of the **Avaya IP End Point** license.

Avaya Radvision Prerequisites

- IP Office to Avaya Radvision interoperation is supported with Avaya Radvision components running Avaya Radvision Release 7.7 software and higher.
- The Scopia XT5000 in the customer's DMZ requires an Avaya Radvision **SCOPIA XT Series SMB Edition** license or **SCOPIA XT Series MCU Edition** license for either 4 or 9 conference parties.
- A Scopia XT Desktop Server is required for support of **Scopia PC Desktop** and **Scopia Mobile** users.

2.3 Checking the IP Office Licenses

IP Office licenses are 32-character strings that are unique to the IP Office system. Each IP Office system has a **Dongle Serial Number** or **System Identification** which is used as the key used to validate whether a license is valid for the system.

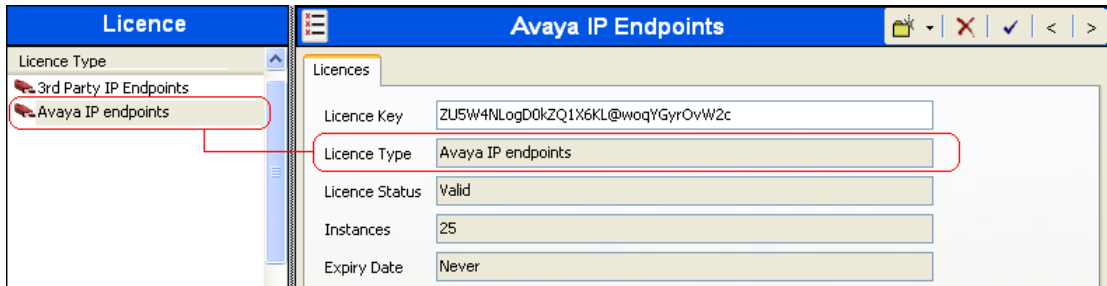

The following IP Office licenses are used:

- Each Scopia XT4200 and Scopia XT5000 device in the deployment is registered with the IP Office system as a SIP extension. To do this, each uses one instance of the **Avaya IP End Point** license.

To check the licenses

The System Status Application displays the status and usage of licenses. It can be used to display the status of licenses plus the number of licenses available and the number used.

1. Start System Status Application and login to the IP Office system.
2. Click on **Resources** in the left-hand navigation panel and select **Licenses**.
3. The information displayed details the status and usage of the licenses currently in the IP Office system's configuration.

2.4 Checking IP Office SIP Support

IP Office systems are by default configured to support SIP extensions on both their LAN1 and LAN2 interfaces. However, you should check the settings and be familiar with their location in the IP Office configuration.

To check IP Office SIP registrar operation

- **Note:** Changes to the LAN1 or LAN2 settings of an IP Office system will require the IP Office system to be rebooted.
1. Using IP Office Manager, receive the configuration from the system.
 2. Select  **System**.
 3. Select either the **LAN1** or **LAN2** tab as required.
 4. Select the **VoIP** sub-tab.

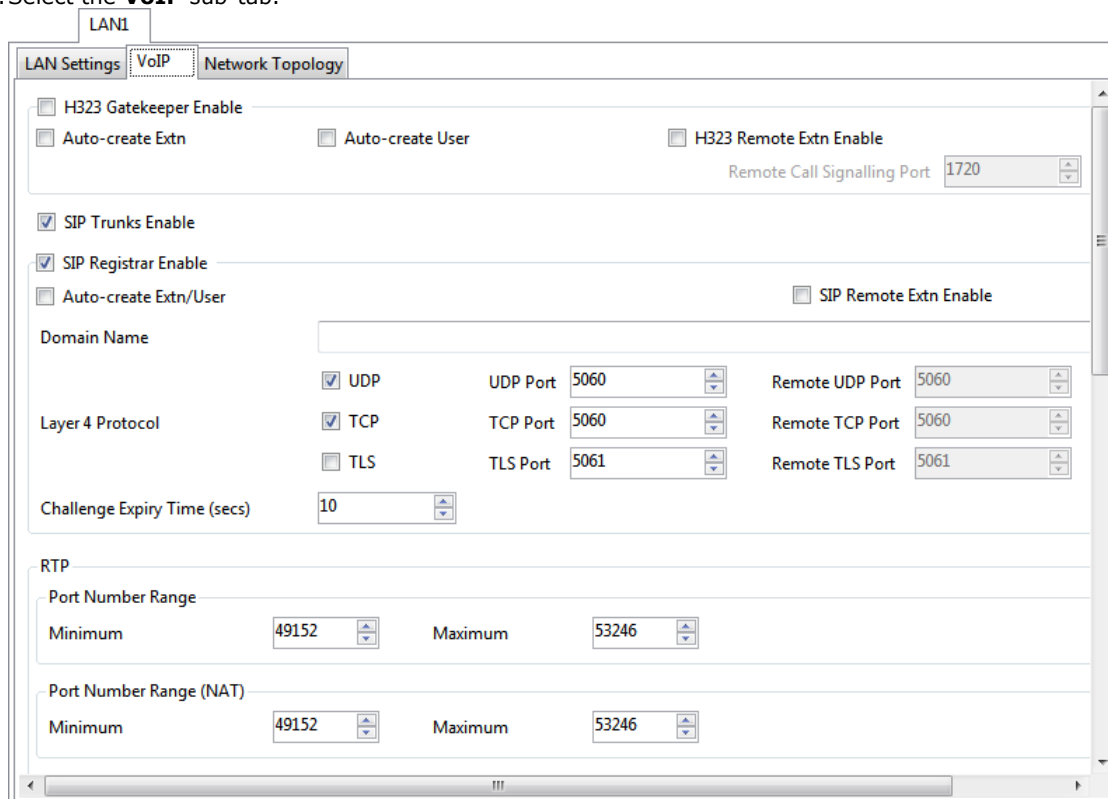

The screenshot shows the 'VoIP' configuration window in IP Office Manager. The 'VoIP' tab is active, and the 'SIP Registrar Enable' checkbox is checked. Other visible settings include 'SIP Trunks Enable' (checked), 'Domain Name' (empty), 'Layer 4 Protocol' (UDP and TCP checked), 'Challenge Expiry Time (secs)' (10), and 'RTP Port Number Range' (Minimum 49152, Maximum 53246).



- Check that **SIP Registrar Enable** is selected. For a large enterprise deployment, check also that **SIP Trunks Enable** is also selected.
- **Domain Name:** *Default = Blank*
This is the local SIP registrar domain name that will be needed by SIP devices in order to register with the IP Office. If this field is left blank, registration is against the LAN IP address. The examples in this documentation all use registration against the LAN IP address.
- **Layer 4 Protocol:** *Default = Both TCP & UDP*
The transport protocol for SIP traffic between the IP Office and SIP extension devices. Both TCP and/or UDP can be used.
- **TCP Port:** *Default = 5060*
The SIP port if using TCP. The default is 5060.
- **UDP Port:** *Default = 5060*
The SIP port if using UDP. The default is 5060.
- **TLS Port:** *Default = 5061*
The SIP port if using TLS. The default is 5061.
- **Challenge Expiry Time (sec):** *Default = 10*
The challenge expiry time is used during SIP extension registration. When a device registers, the IP Office SIP Registrar will send a challenge back to the device and waits for an appropriate response. If the response is not received within this timeout the registration is failed.

5. If you have made any changes, click the  **Save Config** icon to send the configuration back to the IP Office.

2.5 Creating IP Office Users

Create an IP Office user and an IP Office SIP extension entry in the IP Office configuration for each Scopia XT Series device, including the one acting as the MCU.

To add an extension user

1. Using IP Office Manager, receive the configuration from the system.
2. Select  **User**.
3. Click on the  new entry icon and select **User**.
4. Select the **User** tab.

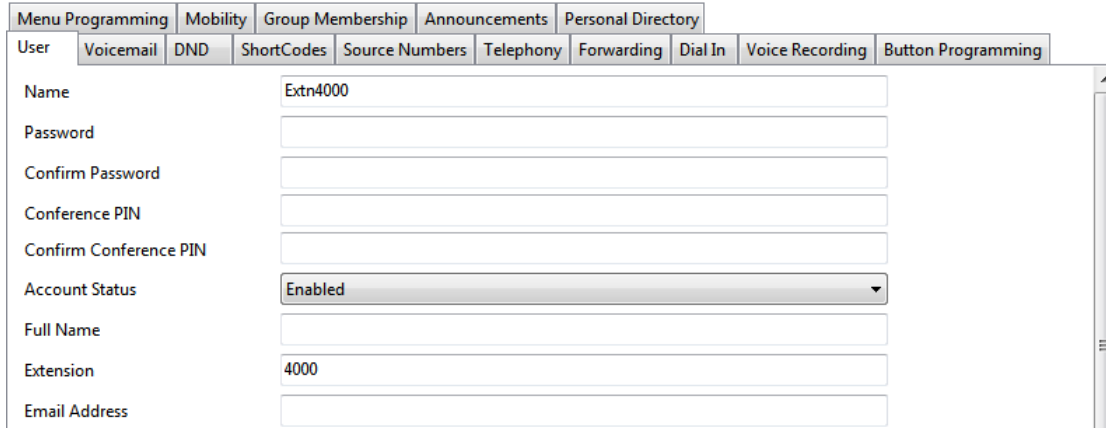

Menu Programming	Mobility	Group Membership	Announcements	Personal Directory					
User	Voicemail	DND	ShortCodes	Source Numbers	Telephony	Forwarding	Dial In	Voice Recording	Button Programming
Name	Extn4000								
Password									
Confirm Password									
Conference PIN									
Confirm Conference PIN									
Account Status	Enabled								
Full Name									
Extension	4000								
Email Address									

- **Name**

Set a name that clearly identifies the role of this user in the IP Office configuration. With the IP Office SIP extension set to **Force Authorization** (the IP Office default and assumed for this example), this field is used as the authorization name that must be set in the SIP device's configuration. This matches the **Authorization Name** set in the Scopia XT Series device's configuration.

- **Extension**

This is the IP Office extension number for calls to the Scopia XT Series device. This should match the SIP ID of the SIP device, which is set through the **User** field of the device's SIP configuration.

5. Select the **Telephony | Supervisor Settings** tab.

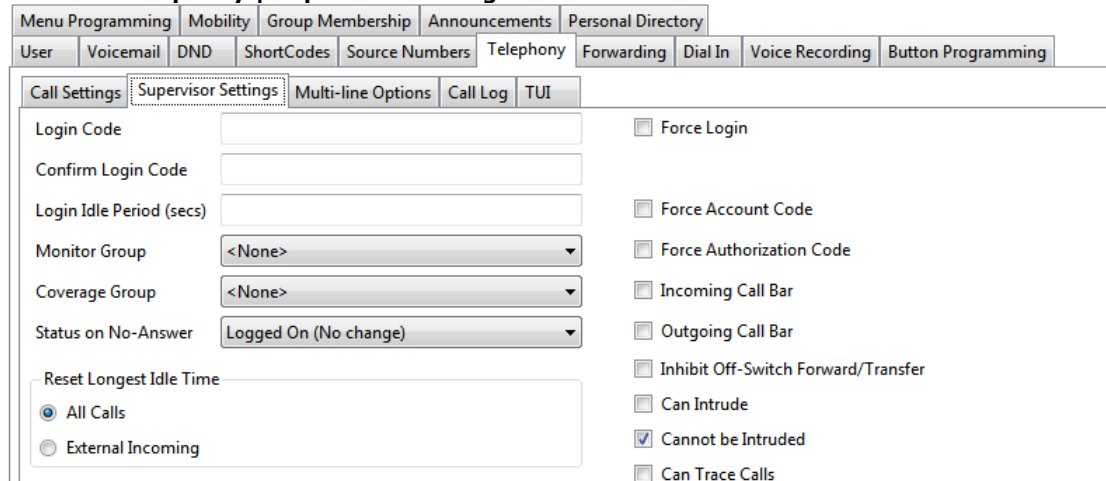

Menu Programming	Mobility	Group Membership	Announcements	Personal Directory					
User	Voicemail	DND	ShortCodes	Source Numbers	Telephony	Forwarding	Dial In	Voice Recording	Button Programming
Call Settings	Supervisor Settings	Multi-line Options	Call Log	TUI					
Login Code					<input type="checkbox"/> Force Login				
Confirm Login Code					<input type="checkbox"/> Force Account Code				
Login Idle Period (secs)					<input type="checkbox"/> Force Authorization Code				
Monitor Group	<None>				<input type="checkbox"/> Incoming Call Bar				
Coverage Group	<None>				<input type="checkbox"/> Outgoing Call Bar				
Status on No-Answer	Logged On (No change)				<input type="checkbox"/> Inhibit Off-Switch Forward/Transfer				
Reset Longest Idle Time					<input type="checkbox"/> Can Intrude				
<input checked="" type="radio"/> All Calls					<input checked="" type="checkbox"/> Cannot be Intruded				
<input type="radio"/> External Incoming					<input type="checkbox"/> Can Trace Calls				

- **Login Code**



With the SIP extension set to **Force Authorization** (the default); this field acts as the authorization password that must be set in the SIP device's configuration. This matches the **Authorization Password** set in the Scopia XT Series device's configuration.

6. Click **OK**.
7. IP Office Manager prompts whether you want to create a VoIP extension for the new user. Select **SIP Extension** and click **OK**.
8. Click the  **Save Config** to save the configuration changes.
9. You now need to configure the matching IP Office extension for the MCU user.

2.6 Creating IP Office SIP Extensions

Create an IP Office user and an IP Office SIP extension entry in the IP Office configuration for each Scopia XT Series device including the one acting as the MCU.

To adding a SIP extension

- Using IP Office Manager, receive the configuration from the system.
- Select  **Extension**.
- If you selected to have a SIP extension automatically created after creating the IP Office user, locate and click on that extension entry. Otherwise, to manually create a new extension, click on the  new entry icon and select **SIP Extension** from the list of possible extension types.
- Select the **Extn** tab.

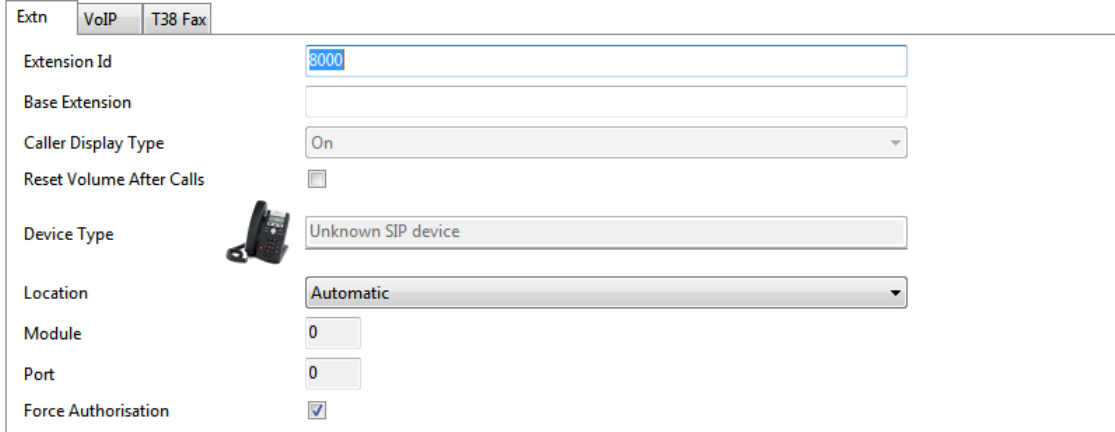

- **Base Extension**

This is used to match the extension to which IP Office user entry that is the default user of the extension. Enter the extension number created for the IP Office user.

- **Force Authorization:** *Default = On*

Leave this setting enabled. When on, SIP devices registering with the IP Office must match the **Name** and **Login Code** configured for the user within the IP Office configuration. These are equivalent to the **Authorization Name** and **Authorization Password** set in the Scopia XT Series device's configuration.

- Select the **VoIP** tab.

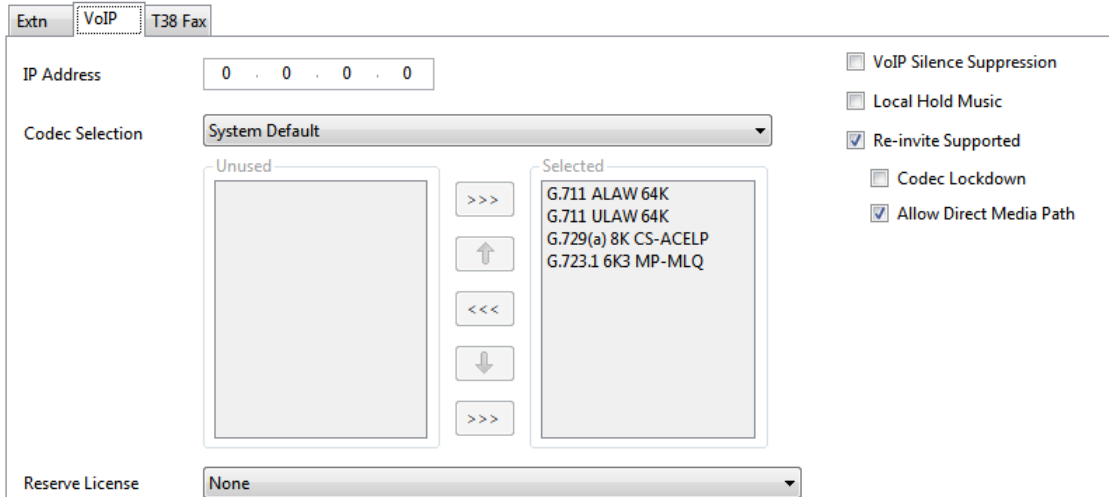

- **Codec Selection**

Do not use the G.729 audio codec with Scopia XT Series extensions. If shown in the **Selected** codecs list, change the **Codec Selection** to **Custom** and move the G.729 codec to the **Unused** list.

- **Re-invite Supported/Allow Direct Media Path**

Enable these settings. Enabling them helps ensure that once a video call is established between the extension and the MCU, the video traffic can be routed directly between the two ends rather than having to be routed via the IP Office system.

- **Reserve License**

Set this field to **Avaya IP Endpoint**. Each Scopia XT Series needs to use an Avaya IP End Point to register with the IP Office system. Normally, following a system restart, the system issues any available licenses to devices in the order that they register with the system. Selecting this option licenses the extension before the device has registered. IP Office Manager greys out the option if there are insufficient licenses available in the configuration.

6. Click **OK**.

7. Repeat the processes of adding an IP Office user and a SIP extension for any other Click the  **Save Config** icon to save the configuration changes to the IP Office.

2.7 Configuring the Scopia XT Series SIP Connection

Make the following changes to the configuration of the Scopia XT Series device to register it with the IP Office as a SIP extension. The settings used match those configured for the SIP user and SIP extension it should use in the IP Office system's configuration.

To configure the MCU SIP settings

1. Using a web browser, log in to the configuration menus of the Scopia XT Series. Refer to the Avaya Radvision manuals for full details.
2. Select **Administrator Settings**.
3. Select **Protocols** and click on **SIP**.

SIP	
Save	
User	XT
Authentication Name	Admin
Authentication Password	*****
UDP/TCP Listening Port	5060
Transport Outbound Call	UDP
Use SIP Registrar	Yes
Registrar DNS Name	
Use SIP Proxy	Yes
Proxy DNS Name	
Proxy Model	Auto
Use TLS	Yes
TLS Listening Port	5061
Verify Certificate	Yes

4. Change the SIP settings as follows:
 - a. **User:** Set this to match the extension number of the IP Office user configured on the IP Office system.
 - b. **Authentication Name:** Set this to match the **Name** set on the matching IP Office user.
 - c. **Authentication Password:** Set this to match the **Login Code** set on the matching IP Office user.
 - d. **UDP/TCP Listening Port:** Set this to match the IP Office system setting. The default is 5060.
 - e. **Transport Outbound Call:** Set this to **UDP**.
 - f. **Use SIP Registrar:** Set this to **Yes**.
 - g. **Registrar DNS Name:** Set this to the IP Office system's IP address or fully qualified domain name.
 - h. **Use SIP Proxy:** Set this to **Yes**.
 - i. **Proxy DNS Name:** Set this to the IP Office system's IP address or fully qualified domain name.
 - j. **Proxy Model:** Leave this set to **Auto**.
 - k. **Use TLS:** Set this to **No**. If you want to use secure SIP connections using TLS certificates refer to the Scopia XT5000 Server for IP Office Administrator Guide.
5. Click **Save**.

Chapter 3.

Large Enterprise Deployment

3. Large Enterprise Deployment

For customers with requirements for large scale and multiple conferences, an Elite series MCU is required (or in fact multiple Elite series MCUs). Each Elite Series MCU supports multiple conference parties in multiple conferences.

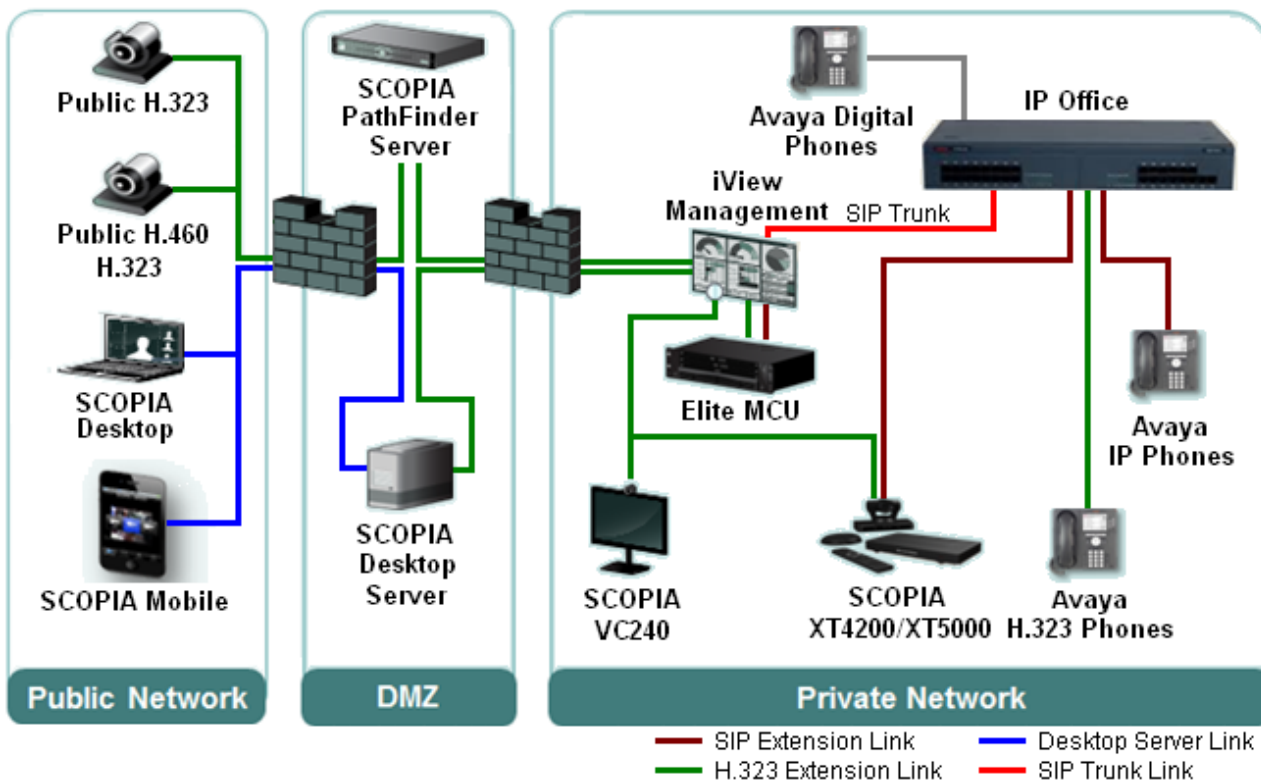

- The customer's private network includes the Elite MCU or MCUs.
- Installed on a customer server, iView Management provides centralized management of all the Avaya Radvision components and conferences including conference scheduling.
 - A SIP trunk links the IP Office system to the iView Management server.
 - The Avaya Radvision video devices on the customer's network connect to the iView Management server.
- The Scopia Desktop Server allows users using the Scopia PC Desktop on PCs and the Scopia Mobile application on mobile devices to join conferences. Placed in the customer's DMZ, the Scopia Desktop Server performs NAT and firewall functions for users external to the customer's private network.
- The Scopia PathFinder Server in the customer's DMZ provides NAT and firewall traversal for external H.323 video devices to join conferences whilst maintaining security of the customer network.
- In this deployment, Scopia VC240 video systems register with the Avaya Radvision system as their gatekeeper. Scopia XT4200 and Scopia XT5000 video systems register with both the IP Office and the Avaya Radvision system.

Supported IP Office Telephones

The following IP Office extension telephones supported for Avaya Radvision:

- **Avaya 96x1 Series H.323 telephones**
- **Avaya 9500 Series digital telephones**
- **Avaya 1600 Series H.323 telephones**
- **Avaya 1408 and 1416 digital telephones**
- **Avaya B179 SIP conference telephone**

3.1 IP Office Deployment Process

The following stages are gone through in the process of integrating the IP Office and Avaya Radvision systems.

1. [Check the prerequisites](#) ^[29].
2. [Check or add the IP Office licenses](#) ^[30].
3. [Check SIP support](#) ^[31].
4. [Add the SIP trunk](#) ^[33].
5. [Add a system short code to route calls](#) ^[36].
6. For any Scopia XT4200 and Scopia XT5000 devices:
 - a. [Create an IP Office user](#) ^[38].
 - b. [Create an IP Office extension](#) ^[39].
 - c. [Configure the Scopia XT Series SIP settings](#) ^[41].

3.2 Prerequisites

General Prerequisites

- This document assumes that you are familiar with using the applications in the IP Office Admin Suite (IP Office Manager, System Status Application, IP Office System Monitor) to configure and monitor an IP Office system.
- This document does not cover the configuration of the Avaya Radvision systems in detail. The separate Avaya Radvision documentation for the Avaya Radvision components used in the deployment cover that configuration. Avaya assume that you are either familiar with the installation and configuration of those components or supported by an experienced Avaya Radvision installer/maintainer.

IP Office Prerequisites

Avaya Radvision devices are supported on IP Office systems meeting the following prerequisites:

- **IP Office Platform:**
IP500 V2 or Server Edition system.
- **IP Office Software Release:**
The IP Office system should be running IP Office Release 8.1 Q3 2012 Service Pack (8.1.52) or higher core software.
- **IP Office Operating Mode:**
The IP Office system must be configured to run in either IP Office Essential Edition, IP Office Preferred Edition, IP Office Advanced Edition or Server Edition operating mode.
- **VCM Resources:**
Calls to and from IP devices (extension and trunks) require the IP Office system to support VCM channels. For IP Office IP500 V2 system those are provided by the installation of IP500 VCM cards or IP500 Combinations cards. Refer to the IP Office Installation Manual for full details. For Server Edition systems, VCM channels are provided without requiring any specific hardware or license.
- **IP Office Licenses:**
The following IP Office licenses are used specifically for the deployment:
 - The SIP trunk between the IP Office system and the iView Management server requires an IP Office **SIP Trunk Channels** license.

Avaya Radvision Prerequisites

- IP Office to Avaya Radvision interoperation is supported with Avaya Radvision components running Avaya Radvision Release 7.7 software and higher.

3.3 Checking the IP Office Licenses

IP Office licenses are 32-character strings that are unique to the IP Office system. Each IP Office system has a **Dongle Serial Number** or **System Identification** which is used as the key used to validate whether a license is valid for the system.

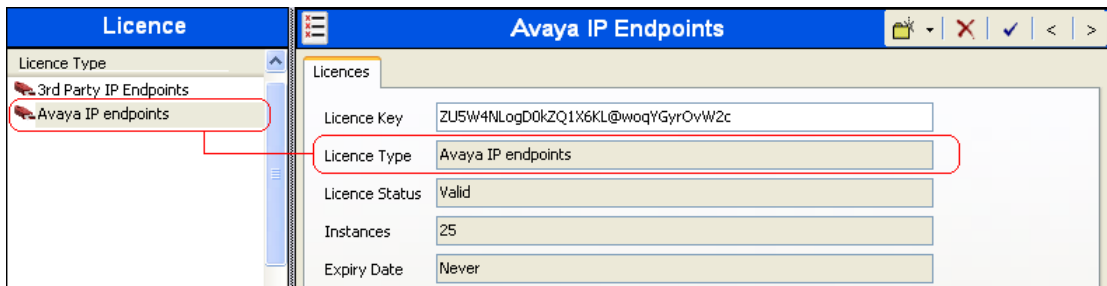

The following IP Office licenses are used:

- The SIP trunk between the IP Office system and the iView Management server requires an IP Office **SIP Trunk Channels** license.
- Each Scopia XT4200 and Scopia XT5000 device in the deployment is registered with the IP Office system as a SIP extension. To do this, each uses one instance of the **Avaya IP End Point** license.

To check the licenses

The System Status Application displays the status and usage of licenses. It can be used to display the status of licenses plus the number of licenses available and the number used.

1. Start System Status Application and login to the IP Office system.
2. Click on **Resources** in the left-hand navigation panel and select **Licenses**.
3. The information displayed details the status and usage of the licenses currently in the IP Office system's configuration.

3.4 Checking IP Office SIP Support

IP Office systems are by default configured to support SIP extensions on both their LAN1 and LAN2 interfaces. However, you should check the settings and be familiar with their location in the IP Office configuration.

To check IP Office SIP registrar operation

- **Note:** Changes to the LAN1 or LAN2 settings of an IP Office system will require the IP Office system to be rebooted.
1. Using IP Office Manager, receive the configuration from the system.
 2. Select  **System**.
 3. Select either the **LAN1** or **LAN2** tab as required.
 4. Select the **VoIP** sub-tab.

The screenshot shows the 'VoIP' configuration window for LAN1. The 'SIP Registrar Enable' checkbox is checked. Below it, the 'Domain Name' field is empty. Under 'Layer 4 Protocol', both 'UDP' and 'TCP' are checked. The 'Challenge Expiry Time (secs)' is set to 10. The 'RTP' section shows 'Port Number Range' with a minimum of 49152 and a maximum of 53246. The 'Port Number Range (NAT)' section also shows a minimum of 49152 and a maximum of 53246. Other settings like 'H323 Gatekeeper Enable', 'Auto-create Extn', 'Auto-create User', 'H323 Remote Extn Enable', and 'SIP Remote Extn Enable' are unchecked. The 'Remote Call Signalling Port' is set to 1720. The 'Remote UDP Port', 'Remote TCP Port', and 'Remote TLS Port' are all set to 5060, 5060, and 5061 respectively.

- Check that **SIP Registrar Enable** is selected. For a large enterprise deployment, check also that **SIP Trunks Enable** is also selected.
- **Domain Name:** *Default = Blank*
This is the local SIP registrar domain name that will be needed by SIP devices in order to register with the IP Office. If this field is left blank, registration is against the LAN IP address. The examples in this documentation all use registration against the LAN IP address.
- **Layer 4 Protocol:** *Default = Both TCP & UDP*
The transport protocol for SIP traffic between the IP Office and SIP extension devices. Both TCP and/or UDP can be used.
- **TCP Port:** *Default = 5060*
The SIP port if using TCP. The default is 5060.
- **UDP Port:** *Default = 5060*
The SIP port if using UDP. The default is 5060.
- **TLS Port:** *Default = 5061*
The SIP port if using TLS. The default is 5061.
- **Challenge Expiry Time (sec):** *Default = 10*
The challenge expiry time is used during SIP extension registration. When a device registers, the IP Office SIP Registrar will send a challenge back to the device and waits for an appropriate response. If the response is not received within this timeout the registration is failed.

5. If you have made any changes, click the  **Save Config** icon to send the configuration back to the IP Office.

3.5 System Default Codecs

By default, all IP extensions and lines added to an IP Office system's configuration use that system's default codec preferences. This is shown by the **Codec Selection** settings the individual trunk or extension being set to **System Default**. Using this setting simplifies configuration and ensure consistent operation. However, if necessary, the individual codec preferences for a particular extension or line can be adjusted.

The IP Office supports G.711, G.729a, G.723 and G.722. However, G.722 is not supported if the system contains any IP400 VCM cards. Avaya Radvision systems do not support G.723 and only support G.729 if additional licenses for the codec are added to the Avaya Radvision system configuration.

To check and changing the default system codec preferences

1. Using IP Office Manager, receive the configuration from the system.

2. Select  **System**.

3. Select the **Codecs** sub-tab.

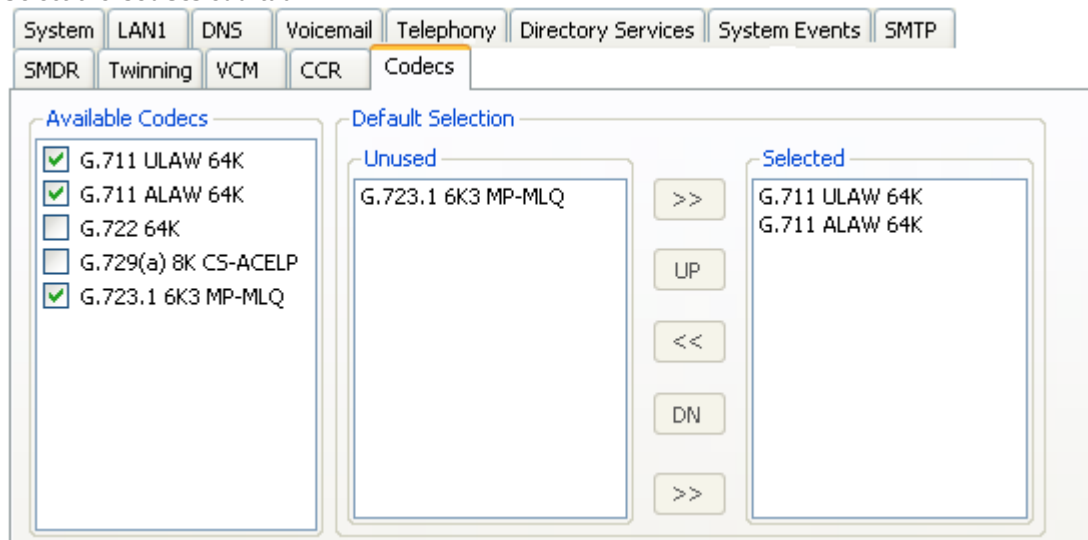

4. The **Available Codecs** list shows which codecs the system supports. The codecs in this list which enabled are those that can be used in other configuration forms including the adjacent default selection.

- **! WARNING**

Deselecting a codec from the **Available Codecs** list will automatically remove that codec from any line or extension codec lists which have been edited to use that codec. Reselecting that codec with not automatically add the codec back to those lists.



5. The **Default Selection** section is used to set the default codec preference order. This is used by all IP extensions and lines on the system that have their **Codec Selection** setting set to **System Default**. This is the default for all new added IP extension and lines.

6. If these settings need to be changed, do so and then save the configuration back to the system.

3.6 Adding the SIP Trunk

The IP Office uses a SIP trunk to connect with the iView Management server. This trunk is used to route calls from the IP Office system to the Avaya Radvision video conferencing system.

To add a SIP trunk to the IP Office

- Using IP Office Manager, receive the configuration from the system.
- Select  **Line**.
- Click on the  new entry icon and select **SIP Line**.
- Select the **SIP Line** tab.
 - ITSP Domain Name**
Set this to the IP address or the fully qualified domain name of the iView Management server.
- Select the **SIP URI** tab. At least one URI is required.

SIP Line Transport SIP URI VoIP T38 Fax SIP Credentials

Channel	Groups	Via	Local URI	Contact	Display Name	PAI	Credential	Max Calls
2	800 800	<None>				None	0: <Non...	10

Add...
Remove
Edit...

Edit Channel

Via: <None>

Local URI: Use Internal Data

Contact: Use Internal Data

Display Name: Use Internal Data

PAI: None

Registration: 0: <None>

Incoming Group: 800

Outgoing Group: 800

Max Calls per Channel: 10

OK
Cancel

- Click **Add**.
- Enter a unique line group number in the **Incoming Group** field. This can then be used to setup specific incoming call routing for calls the IP Office receives that are matched to this URI. For this example we used **800**.
- Enter a unique line group number in the **Outgoing Group** field. This can then be used as the destination for outgoing calls in IP Office [short codes](#)^[36]. For this example we used **800**.
- Click **OK**.

6. Select the **VoIP** tab.

The screenshot shows the VoIP configuration tab with the following settings:

- Codec Selection:** System Default (dropdown)
- Unused:** (Empty list)
- Selected:** G.711 ULAW 64K, G.711 ALAW 64K, G.722 64K, G.729(a) 8K CS-ACELP, G.723.1 6K3 MP-MLQ
- Options:**
 - VoIP Silence Suppression
 - Re-invite Supported
 - Use Offerer's Preferred Code
 - Codec Lockdown
 - PRACK/100rel Supported
- Fax Transport Support:** None (dropdown)
- Call Initiation Timeout (s):** 4 (spin box)
- DTMF Support:** Inband (dropdown, highlighted with a red box)

a. Change the **DTMF Support** setting to **Inband**. This is necessary to ensure that the entry of conference PINs works.

b. Click **OK**.

7. Click the  **Save Config** icon to send the configuration back to the IP Office.

3.7 Configuring the Scopia MCU

Configure the Elite Series MCU with details of the IP Office as the gatekeeper/SIP proxy.

To configure the Scopia MCU

1. In the Scopia Management configuration menus, select **Resource Management | Gatekeeper/Sip proxy**.
2. Select **Add** and enter details that match the IP Office and its SIP settings.

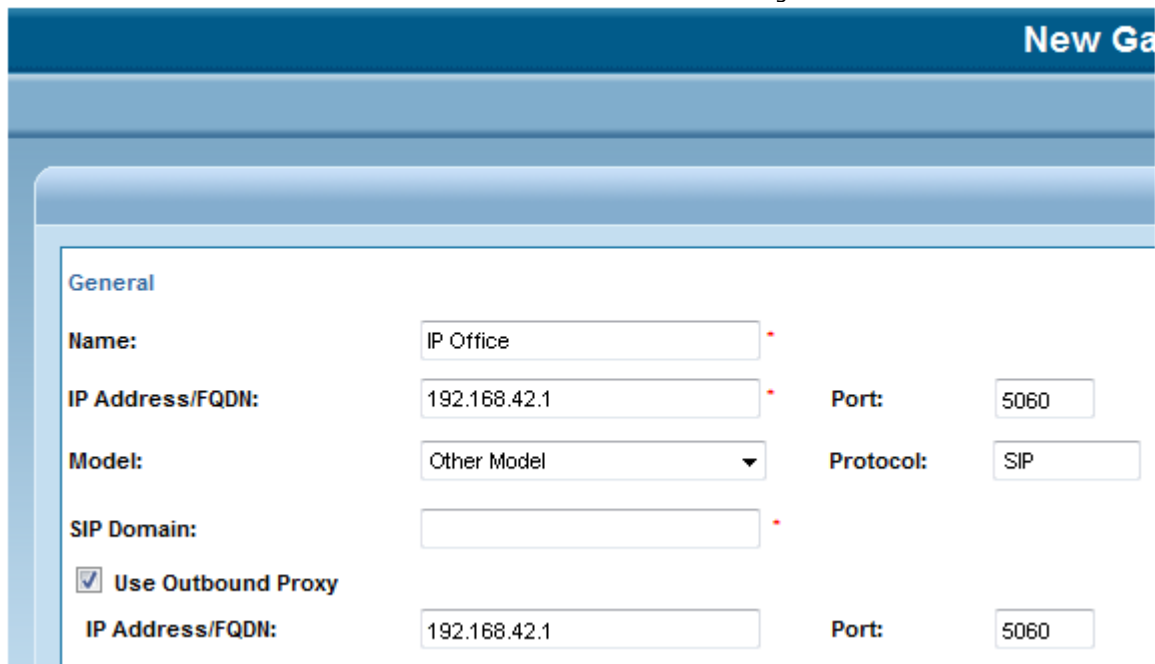

The screenshot shows a web-based configuration interface for a Scopia MCU. At the top right, there is a blue header with the text "New Gatekeeper". Below this is a form titled "General" with the following fields:

Name:	<input type="text" value="IP Office"/>		
IP Address/FQDN:	<input type="text" value="192.168.42.1"/>	Port:	<input type="text" value="5060"/>
Model:	<input type="text" value="Other Model"/>	Protocol:	<input type="text" value="SIP"/>
SIP Domain:	<input type="text"/>		
<input checked="" type="checkbox"/> Use Outbound Proxy			
IP Address/FQDN:	<input type="text" value="192.168.42.1"/>	Port:	<input type="text" value="5060"/>

3.8 Adding a Short Code

In order to route internal calls dialed on the IP Office system to the Avaya Radvision system, a system short code can be used. This short code is set with its destination as the **Outgoing Group** number of the SIP trunk to the iView Management server.

Once a short code has been created, it can be used by IP Office users to access the video conferencing system. It can also be used as the destination for external calls in IP Office Incoming Call Routes and in Voicemail Pro call flow actions.

3.8.1 Simple Short Code Example

In this example, a single system short code is used to allow users to access the auto attendant service configured on the Avaya Radvision MCU.

To add a simple system short code to route calls to the conference server

1. Using IP Office Manager, receive the configuration from the system.

2. Select  **Short Code**.

3. Click on the  new entry icon and select **Short Code**.

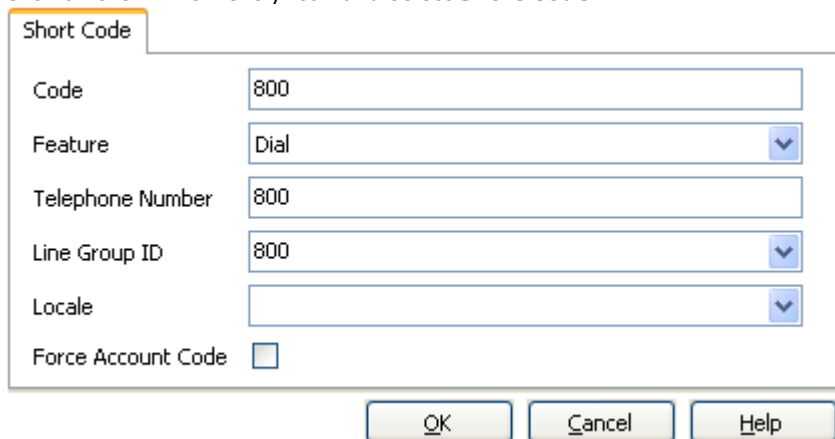

Code	800
Feature	Dial
Telephone Number	800
Line Group ID	800
Locale	
Force Account Code	<input type="checkbox"/>

OK Cancel Help

- **Code**

This field will be used to trigger a short code match to the dialing. For this example, we want this short code used whenever the IP Office system sees 800 dialed by a user.

- **Feature**

The action that this short code should perform when matched is to dial a number so the **Feature** selected is **Dial**.

- **Telephone Number**

This number should match the service configured as the auto attendant service on the Avaya Radvision MCU. The caller is taken to an interactive menu of conference rooms from which they can select the conference they want to enter.

- **Line Group ID**



This field should be set to match the **Outgoing Group** number set on the SIP trunk URI added to the [SIP trunk](#) to the iView Management server. For this example we used 800.

4. Click the  **Save Config** icon to send the configuration back to the IP Office.

3.8.2 Flexible Short Code Example

In this example, a single system short code is used to allow users to access any service configured on the Avaya Radvision MCU. It assumes that the video services have all been given consistent numbering in the range 8000 to 8999.

To add a flexible system short code to route calls to the conference services

1. Using IP Office Manager, receive the configuration from the system.
2. Select  **Short Code**.
3. Click on the  new entry icon and select **Short Code**.

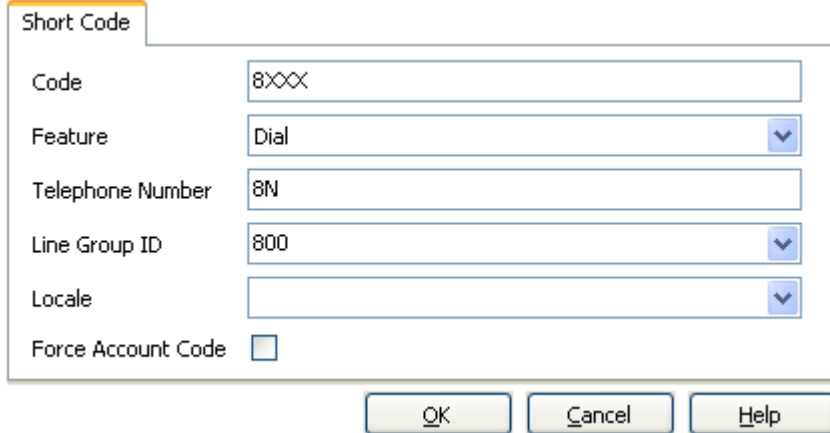

Code	8XXX
Feature	Dial
Telephone Number	8N
Line Group ID	800
Locale	
Force Account Code	<input type="checkbox"/>

OK Cancel Help



- **Code**
Setting the Code to **8XXX** will match the dialing of any four digit number prefixed with 8.
- **Feature**
The action that this short code should perform when matched is to dial a number so the **Feature** selected is **Dial**.
- **Telephone Number**
Setting the Telephone Number to 8N will replace the **N** with the digits dialed for **XXX**.
- If the number matches the service configured as the auto attendant service, the caller is taken to an interactive menu of conference rooms from which they can select the conference they want to enter,
- If the number matches another service, the user either starts or joins that conference service.
- **Line Group ID**
This field should be set to match the **Outgoing Group** number set on the SIP trunk URI added to the [SIP trunk](#) ⁽³³⁾ to the iView Management server. For this example we used 800.

4. Click the  **Save Config** icon to send the configuration back to the IP Office.

3.9 Creating IP Office Users

Create IP Office user and extension entries in the IP Office configuration for each Scopia XT4200 and Scopia XT5000 device as they register with both the IP Office system and the Avaya Radvision system. These entries are not required for the Scopia VC240 as it only registers with the Avaya Radvision system.

To add an extension user

1. Using IP Office Manager, receive the configuration from the system.
2. Select  **User**.
3. Click on the  new entry icon and select **User**.
4. Select the **User** tab.

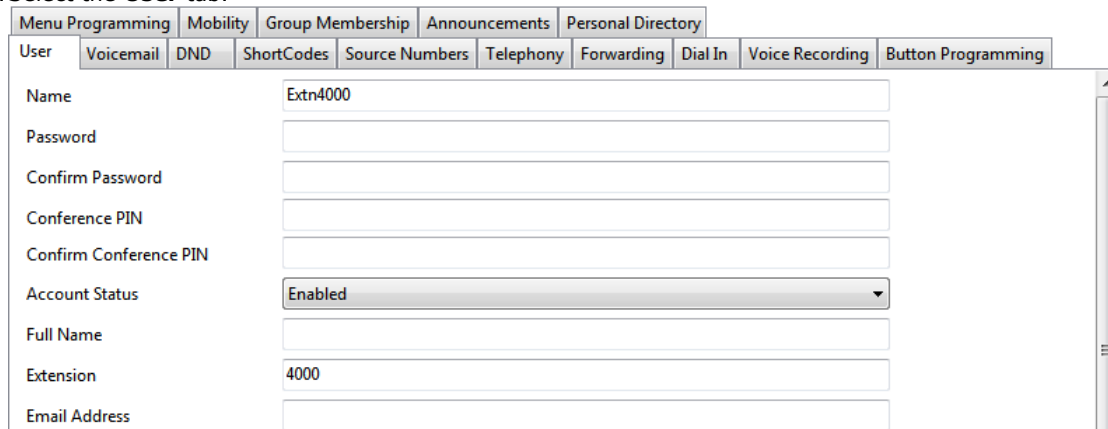

The screenshot shows the 'User' configuration page in IP Office Manager. The 'User' tab is selected, and the 'Name' field is filled with 'Extn4000'. The 'Extension' field is filled with '4000'. The 'Account Status' dropdown is set to 'Enabled'. Other fields like Password, Confirm Password, Conference PIN, and Full Name are empty.

- **Name**
Set a name that clearly identifies the role of this user in the IP Office configuration. With the IP Office SIP extension set to **Force Authorization** (the IP Office default and assumed for this example), this field is used as the authorization name that must be set in the SIP device's configuration. This matches the **Authorization Name** set in the Scopia XT Series device's configuration.
- **Extension**
This is the IP Office extension number for calls to the Scopia XT Series device. This should match the SIP ID of the SIP device, which is set through the **User** field of the device's SIP configuration.

5. Select the **Telephony | Supervisor Settings** tab.

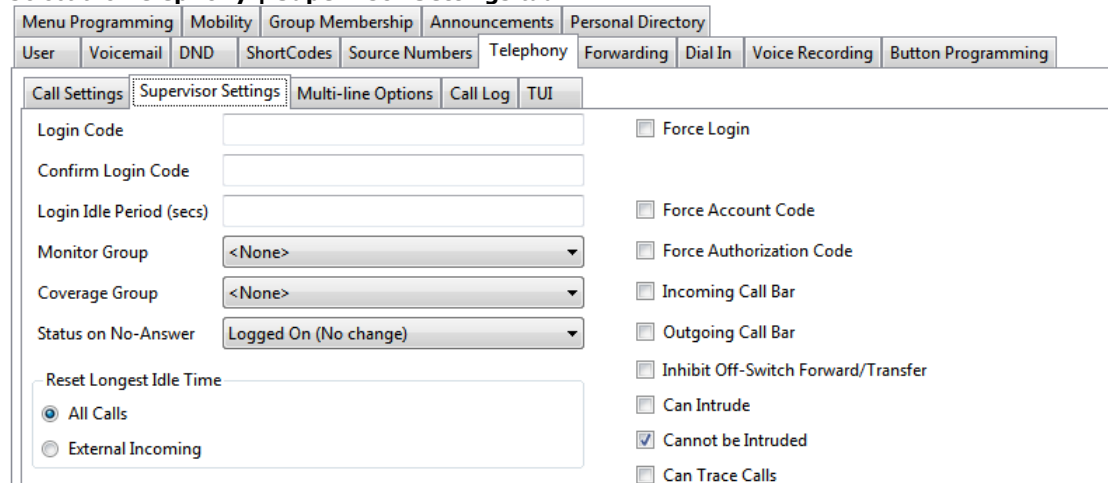

The screenshot shows the 'Supervisor Settings' tab in the IP Office Manager. The 'Login Code' field is empty. The 'Status on No-Answer' dropdown is set to 'Logged On (No change)'. The 'Cannot be Intruded' checkbox is checked. Other checkboxes like 'Force Login', 'Force Account Code', and 'Can Intrude' are unchecked.

- **Login Code**
With the SIP extension set to **Force Authorization** (the default); this field acts as the authorization password that must be set in the SIP device's configuration. This matches the **Authorization Password** set in the Scopia XT Series device's configuration.

6. Click **OK**.
7. IP Office Manager prompts whether you want to create a VoIP extension for the new user. Select **SIP Extension** and click **OK**.
8. Click the  **Save Config** to save the configuration changes.
9. You now need to configure the matching IP Office extension for the MCU user.

3.10 Creating IP Office SIP Extensions

Create IP Office user and extension entries in the IP Office configuration for each Scopia XT4200 and Scopia XT5000 device as they register with both the IP Office system and the Avaya Radvision system. These entries are not required for the Scopia VC240 as it only registers with the Avaya Radvision system.

To adding a SIP extension

1. Using IP Office Manager, receive the configuration from the system.

2. Select  **Extension**.

3. If you selected to have a SIP extension automatically created after creating the IP Office user, locate and click on that extension entry. Otherwise, to manually create a new extension, click on the  new entry icon and select **SIP Extension** from the list of possible extension types.

4. Select the **Extn** tab.

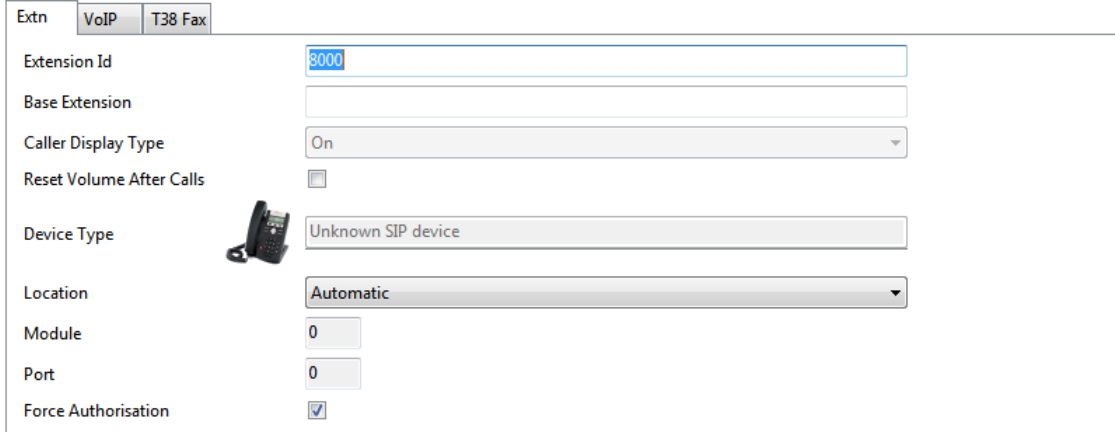

- **Base Extension**

This is used to match the extension to which IP Office user entry that is the default user of the extension. Enter the extension number created for the IP Office user.

- **Force Authorization:** *Default = On*

Leave this setting enabled. When on, SIP devices registering with the IP Office must match the **Name** and **Login Code** configured for the user within the IP Office configuration. These are equivalent to the **Authorization Name** and **Authorization Password** set in the Scopia XT Series device's configuration.

5. Select the **VoIP** tab.

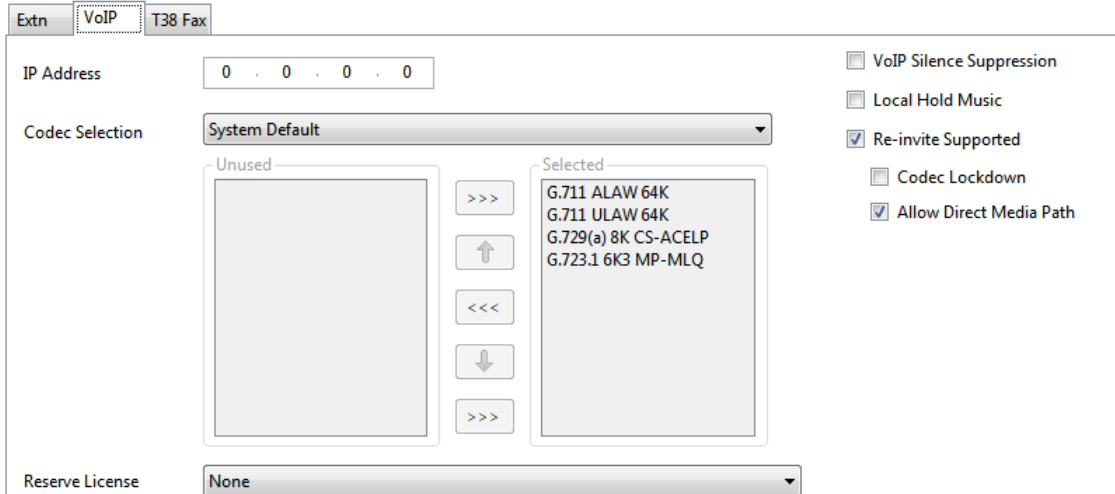

- **Codec Selection**

Do not use the G.729 audio codec with Scopia XT Series extensions. If shown in the **Selected** codecs list, change the **Codec Selection** to **Custom** and move the G.729 codec to the **Unused** list.

- **Re-invite Supported/Allow Direct Media Path**

Enable these settings. Enabling them helps ensure that once a video call is established between the extension and the MCU, the video traffic can be routed directly between the two ends rather than having to be routed via the IP Office system.

- **Reserve License**

Set this field to **Avaya IP Endpoint**. Each Scopia XT Series needs to use an Avaya IP End Point to register with the IP Office system. Normally, following a system restart, the system issues any available licenses to devices in the order that they register with the system. Selecting this option licenses the extension before the device has registered. IP Office Manager greys out the option if there are insufficient licenses available in the configuration.

6. Click **OK**.

7. Repeat the processes of adding an IP Office user and a SIP extension for any other Click the  **Save Config** icon to save the configuration changes to the IP Office.

3.11 Configuring the Scopia XT Series SIP Connection

Make the following changes to the configuration of the Scopia XT Series device to register it with the IP Office as a SIP extension. The settings used match those configured for the SIP user and SIP extension it should use in the IP Office system's configuration.

To configure the MCU SIP settings

1. Using a web browser, log in to the configuration menus of the Scopia XT Series. Refer to the Avaya Radvision manuals for full details.
2. Select **Administrator Settings**.
3. Select **Protocols** and click on **SIP**.

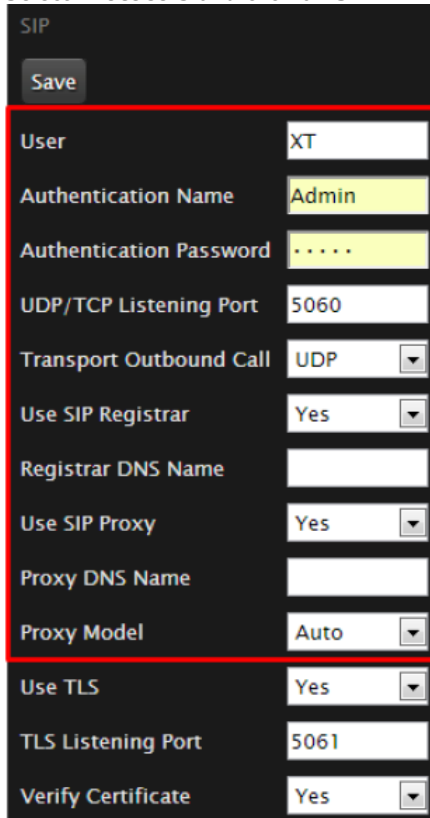

SIP	
Save	
User	XT
Authentication Name	Admin
Authentication Password
UDP/TCP Listening Port	5060
Transport Outbound Call	UDP
Use SIP Registrar	Yes
Registrar DNS Name	
Use SIP Proxy	Yes
Proxy DNS Name	
Proxy Model	Auto
Use TLS	Yes
TLS Listening Port	5061
Verify Certificate	Yes

4. Change the SIP settings as follows:
 - a. **User:** Set this to match the extension number of the IP Office user configured on the IP Office system.
 - b. **Authentication Name:** Set this to match the **Name** set on the matching IP Office user.
 - c. **Authentication Password:** Set this to match the **Login Code** set on the matching IP Office user.
 - d. **UDP/TCP Listening Port:** Set this to match the IP Office system setting. The default is 5060.
 - e. **Transport Outbound Call:** Set this to **UDP**.
 - f. **Use SIP Registrar:** Set this to **Yes**.
 - g. **Registrar DNS Name:** Set this to the IP Office system's IP address or fully qualified domain name.
 - h. **Use SIP Proxy:** Set this to **Yes**.
 - i. **Proxy DNS Name:** Set this to the IP Office system's IP address or fully qualified domain name.
 - j. **Proxy Model:** Leave this set to **Auto**.
 - k. **Use TLS:** Set this to **No**. If you want to use secure SIP connections using TLS certificates refer to the Scopia XT5000 Server for IP Office Administrator Guide.
5. Click **Save**.

Chapter 4.

Document History

4. Document History

24th April 2014	06e	<ul style="list-style-type: none">• Confirmation that with IP Office 9.0, BFCP is support. Also SIP trunk support if using Direct Media. [IPOFFICE-46974]
16th April 2015	06f	<ul style="list-style-type: none">• Correct appearance of old Avaya Communicator product name.
2nd July 2015	07a	<ul style="list-style-type: none">• Updated details for creating IP Office SIP extension.• SIP Registrar settings merged into LAN VoIP settings.• Updated Scopia MCU menu for configuring SIP users.

Index

A

Authentication Name 25, 41
 Authentication Password 25, 41
 Auto-create Extn/User 21, 31
 Avaya IP End Point License 19, 20, 30

C

CD Audio 10
 Challenge Expiry Time 21, 31
 Codecs 32
 Conference
 PIN 33
 Conference Room Video Systems 10
 Conference Servers 10
 Conferences
 Multiple 14, 28

D

Default
 Codecs 32
 Deployment
 Medium 14, 28
 Small 13, 18
 Domain Name 21, 31, 33
 DTMF Support 33

E

Elite Series Conference Servers 10
 Enable
 SIP Registrar 21, 31
 SIP Trunk 21, 31
 Extension 23, 39

G

Group 33
 Group ID 36

H

HD Audio 10

I

Inband 33
 Incoming Group 33
 IP Office
 Checking Licenses 20, 30
 Codecs 32
 SIP Extension Support 21, 31
 SIP Ports 21, 31
 System VoIP Settings 21, 31
 IP Office Manager
 Load configuration 21, 22, 23, 31, 32, 33, 36, 37,
 38, 39
 iPad 10
 iPhone 10
 iPod Touch 10
 ITSP Domain Name 33
 iView Management 10, 14, 28

L

Layer 4 Protocol 21, 31
 License 23, 39
 Avaya IP End Point 19, 20, 30
 SCOPIA XT Series MCU Edition 13, 18
 SCOPIA XT Series SMB Edition 13, 18
 SIP Trunk Channels 29, 30
 Licenses
 Checking 20, 30
 Line Group ID 36
 Listening Port 25, 41

M

Medium Deployment 14, 28

O

Outgoing Group 33
 Outgoing group number 36

P

PIN 33
 Port
 Listening Port 25, 41
 SIP TCP Port 21, 31
 SIP UDP Port 21, 31

R

Reserve Avaya IP Endpoint License 23, 39

S

Scopia Desktop Server 10
 Scopia Mobile 10
 Scopia PathFinder Server 10, 14, 28
 Scopia PC Desktop 10
 Scopia VC240 10
 SCOPIA XT Series 10
 SCOPIA XT Series MCU Edition 10
 SCOPIA XT Series MCU Edition License 13, 18
 SCOPIA XT Series SMB Edition 10
 SCOPIA XT Series SMB Edition License 13, 18
 Scopia XT5000 13, 18
 Short code 36
 SIP
 Extension Support 21, 31
 IP Office Ports 21, 31
 SIP Registrar Enable 21, 31
 TCP Port 21, 31
 UDP Port 21, 31
 Use SIP Registrar 25, 41
 SIP trunk 14, 28, 33
 SIP Trunk Channels License 29, 30
 SIP Trunks Enable 21, 31
 SIP URI 33
 Small Deployment 13, 18
 System short code 36
 System Status Application
 Licenses 20, 30
 Resources 20, 30

T

TCP Port 21, 31
 Transport Outbound Call 25, 41
 Trunk
 SIP 33
 Trunk Enable 21, 31

U

UDP Port 21, 31
 URI 33

V

Video Applications 10
 VoIP
 Extension Support 21, 31
 IP Office System Settings 21, 31

Performance figures and data quoted in this document are typical, and must be specifically confirmed in writing by Avaya before they become applicable to any particular order or contract. The company reserves the right to make alterations or amendments to the detailed specifications at its discretion. The publication of information in this document does not imply freedom from patent or other protective rights of Avaya or others.

All trademarks identified by the ® or ™ are registered trademarks or trademarks, respectively, of Avaya Inc. All other trademarks are the property of their respective owners.

This document contains proprietary information of Avaya and is not to be disclosed or used except in accordance with applicable agreements.

© 2015 Avaya Inc. All rights reserved.